

Automatic Dampening System NC8.2

Measuring pipe

Pipe diameter 150 mm

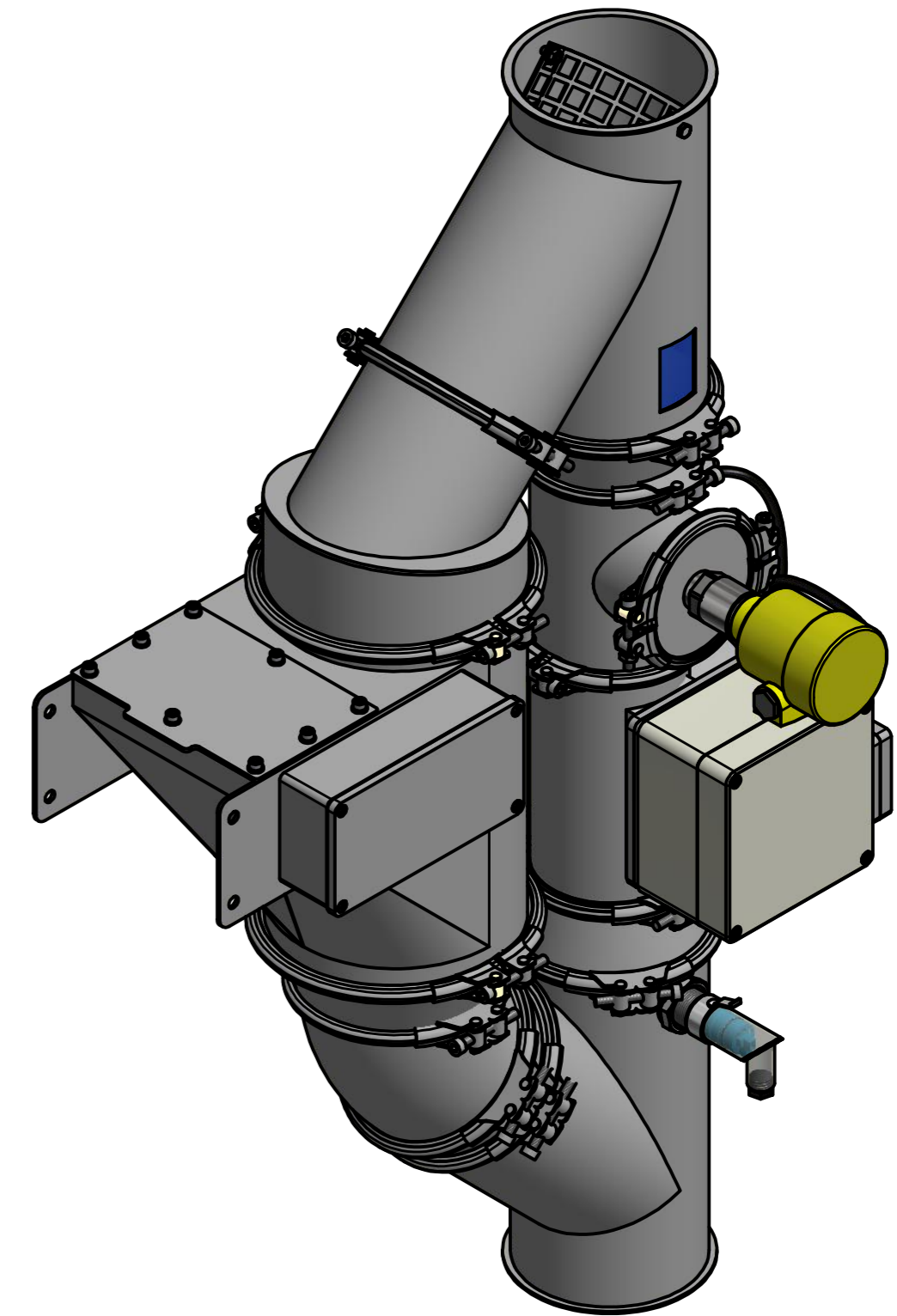
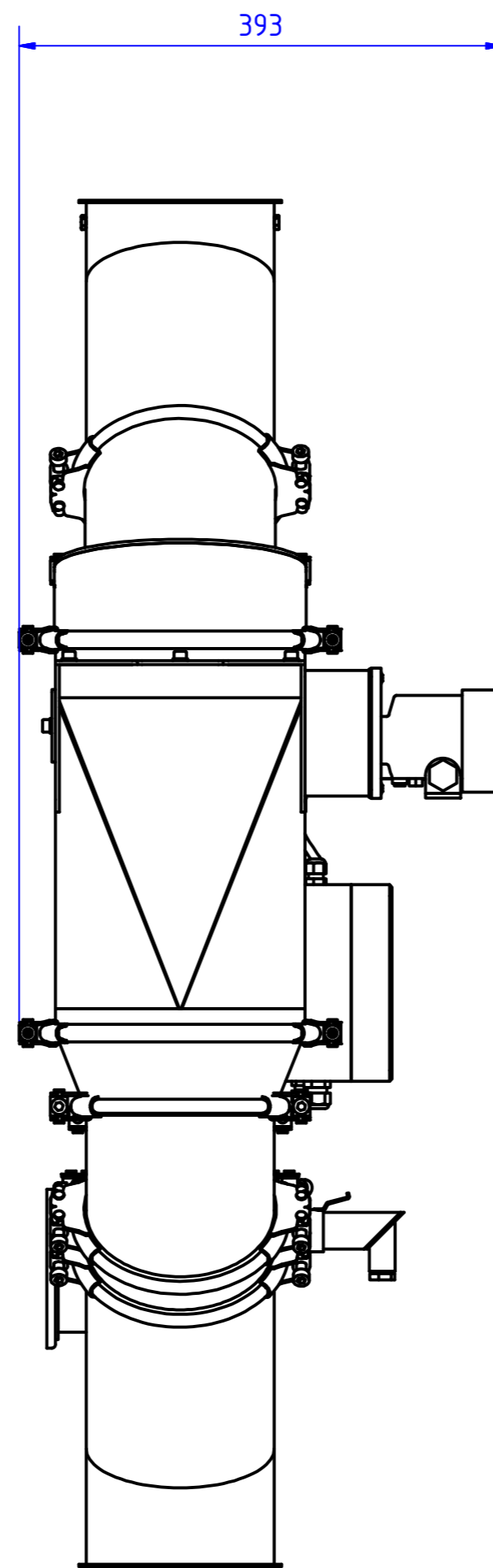
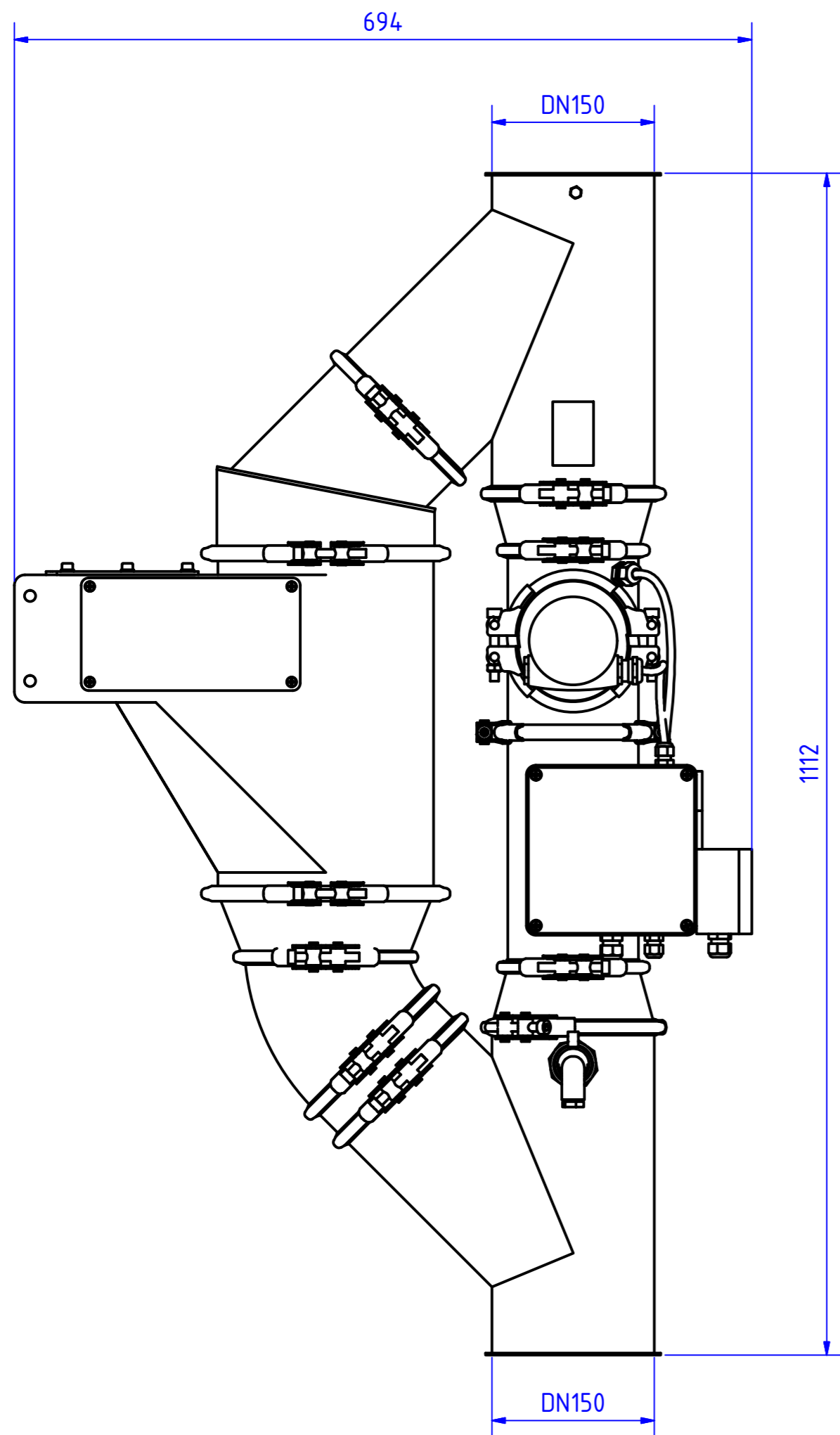

Title	Dimensions		
Module			
Project			
Page	1 / 1	Format	A2
Date	09.10.2018	Author	Cem
Company	FRIEDRICH electronic GmbH & Co. KG Holzmühlerweg 100, D-35457 Lollar, Germany Tel. +49 (0) 6406 - 1509, Fax. +49 (0) 6406 - 6602 Internet: www.friedrich-electronic.de, Email: service@friedrich-electronic.de		
Filename			